

ACS.J1962F-SHL

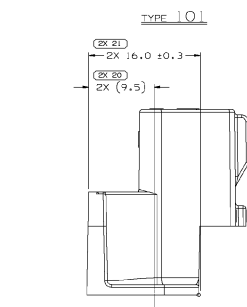
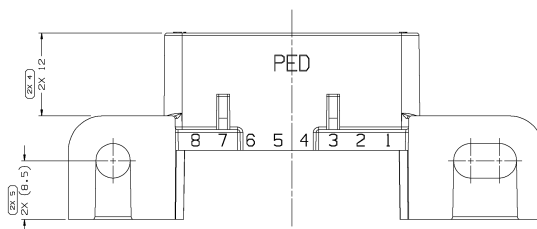
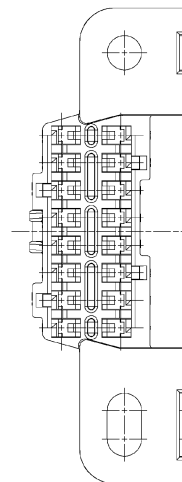
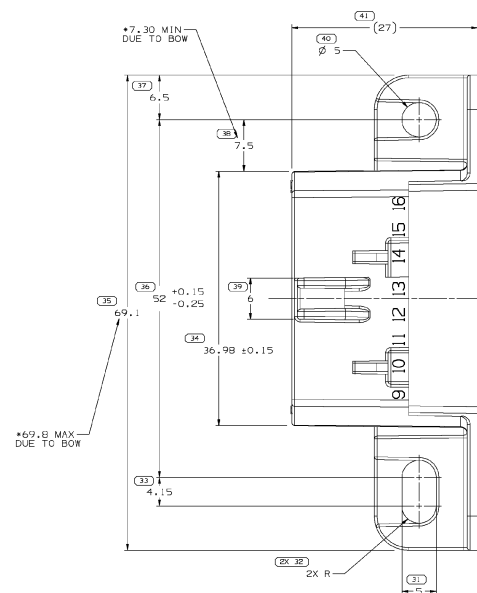
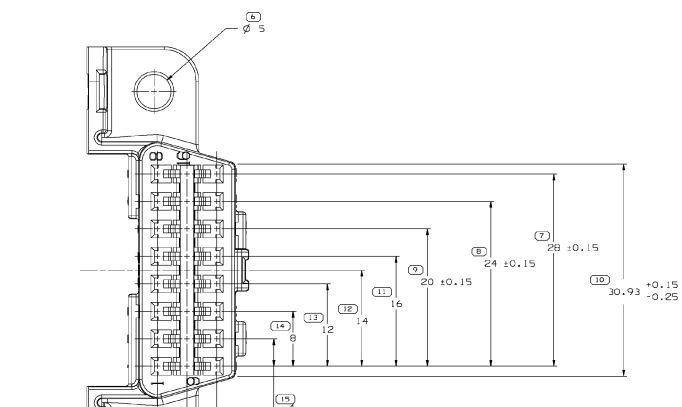
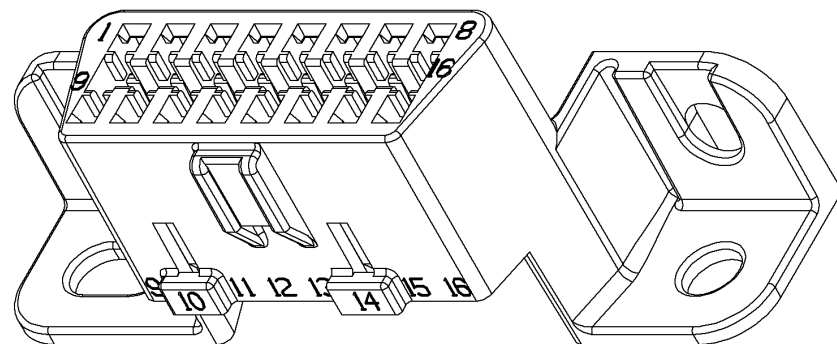
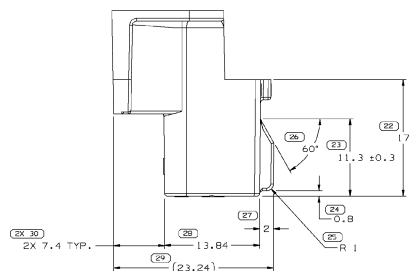

DIMENSIONAL RANGE (MM)									
FROM	0	20	30	70	100	150	200	250	300
TO	20	30	70	100	150	200	250	300	400
TOLERANCE UNLESS OTHERWISE SPECIFIED									
	±0.15	±0.2	±0.3	±0.4	±0.5	±0.6	±0.8	±1	±1.2
ANGULAR TOLERANCE ±2°									